

开关 Switch

产品外观
Photo

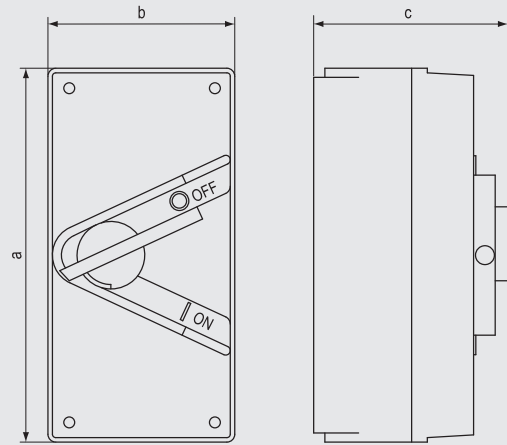

外形尺寸
Dimension



电流(A) Current(A)	极数 Pole	额定工作电压(V) Rated operating voltage (V)	订货号 Model
---------------------	------------	---	--------------

选型 Description	◆◆ IP 66 开关 ◆◆ IP 66 Switch			
	电流(A)	极数	额定工作电压(V)	订货号
	20	1	250	UKF1-120
	20	2	250	UKF1-220
	20	3	500	UKF1-320
	20	4	500	UKF1-420
	35	1	250	UKF1-135
	35	2	250	UKF1-235
	35	3	500	UKF1-335
	35	4	500	UKF1-435
	63	1	250	UKF1-163
	63	2	250	UKF1-263
	63	3	500	UKF1-363
	63	4	500	UKF1-463

参数 Parameter	20				35				63			
	1	2	3	4	1	2	3	4	1	2	3	4
尺寸 Dimension(mm)	a	166	166	166	166	166	166	166	166	166	166	166
	b	83	83	83	83	83	83	83	83	83	83	83
	c	86	86	86	86	86	86	86	86	86	86	86

开关 Switch

产品外观
Photo

A



外形尺寸
Dimension

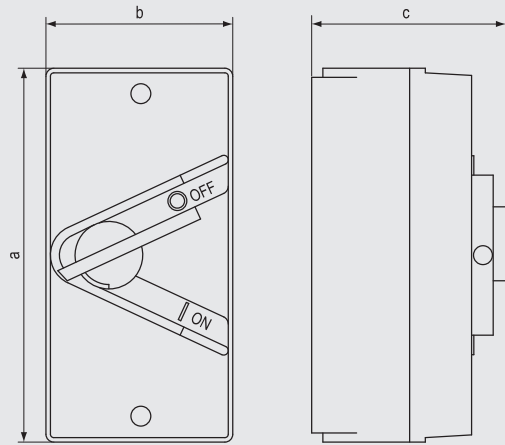

	电流(A) Current(A)	极数 Pole	额定工作电压(V) Rated operating voltage (V)	订货号 Model
选型 Description	▲▲ IP 66 开关 ▲▲ IP 66 Switch			
	20	1	250	UKF2-120
	20	2	250	UKF2-220
	20	3	500	UKF2-320
	20	4	500	UKF2-420
	35	1	250	UKF2-135
	35	2	250	UKF2-235
	35	3	500	UKF2-335
	35	4	500	UKF2-435
	63	1	250	UKF2-163
	63	2	250	UKF2-263
	63	3	500	UKF2-363
	63	4	500	UKF2-463

参数 Parameter	电流(A) Current(A)	20				35				63			
	极数(P) Pole(P)	1	2	3	4	1	2	3	4	1	2	3	4
尺寸 Dimension(mm)	a	166	166	166	166	166	166	166	166	166	166	166	166
	b	83	83	83	83	83	83	83	83	83	83	83	83
	c	86	86	86	86	86	86	86	86	86	86	86	86

开关 Switch

产品外观
Photo



外形尺寸
Dimension

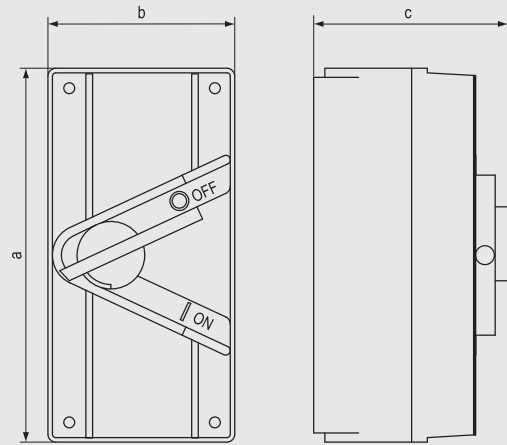

A

电流(A) Current(A)	极数 Pole	额定工作电压(V) Rated operating voltage (V)	订货号 Model
---------------------	------------	---	--------------

选型 Description	◆◆ IP 66 开关 ◆◆ IP 66 Switch			
	电流(A)	极数	额定工作电压(V)	订货号
	20	1	250	UKF3-120
	20	2	250	UKF3-220
	20	3	500	UKF3-320
	20	4	500	UKF3-420
	35	1	250	UKF3-135
	35	2	250	UKF3-235
	35	3	500	UKF3-335
	35	4	500	UKF3-435
	63	1	250	UKF3-163
	63	2	250	UKF3-263
	63	3	500	UKF3-363
	63	4	500	UKF3-463

参数 Parameter	20				35				63			
	1	2	3	4	1	2	3	4	1	2	3	4
尺寸 Dimension(mm)	a	166	166	166	166	166	166	166	166	166	166	166
	b	83	83	83	83	83	83	83	83	83	83	83
	c	86	86	86	86	86	86	86	86	86	86	86

开关 Switch

产品外观
Photo

A



外形尺寸
Dimension

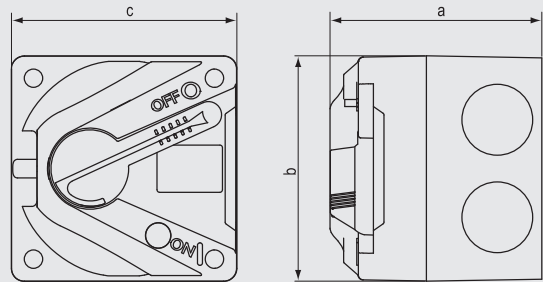

	电流(A) Current(A)	极数 Pole	额定工作电压(V) Rated operating voltage (V)	订货号 Model
选型 Description	◆◆ IP 66 开关 ◆◆ IP 66 Switch			
	10	1	250	UKF4-110
	10	2	250	UKF4-210
	16	1	250	UKF4-116
	16	2	250	UKF4-216
	20	1	250	UKF4-120
	20	2	250	UKF4-220
	35	1	250	UKF4-135
35	2	250	UKF4-235	

参数 Parameter	10		16		20		35	
	1	2	1	2	1	2	1	2
尺寸 Dimension(mm)	a	80	80	80	80	80	80	80
	b	85	85	85	85	85	85	85
	c	85	85	85	85	85	85	85

开关盒 Switchgear Box

产品外观
Photo



外形尺寸
Dimension

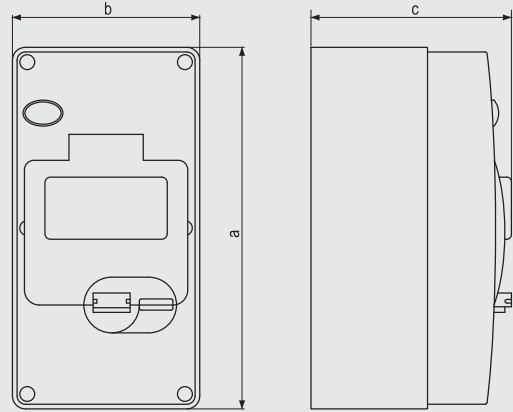

极数
Pole

订货号
Model

◆◆ IP 66 开关盒
◆◆ IP 66 Switchgear Box

最多4个18mm模块
max. 4 x modules (18mm)

56CB1-4N

选型
Description

参数
Parameter

电流(A) Current(A)		-
极数(P) Pole(P)		-
尺寸 Dimension(mm)	a	195
	b	101
	c	108

插头 Plug

产品外观
Photo

外形尺寸
Dimension

A

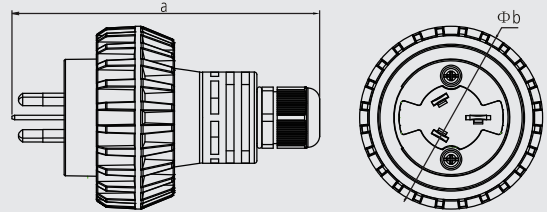

56P310

56P315

56P313*

56P310F



3P 10A 250V



3P 15A 250V



3P 13A 250V



3P 10A 250V

参数
Parameter

电流(A) Current(A)	10	15	13
极数(P) Pole(P)	3	3	3
尺寸 Dimension(mm)	a	118	95
	b	71	79

插头 Plug

产品外观
Photo



外形尺寸
Dimension

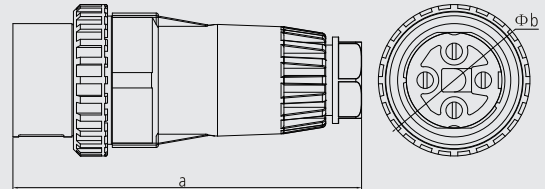

56P320	56P332	56P410	56P420	56P432
3P 20A 250V	3P 32A 250V	4P 10A 500V	4P 20A 500V	4P 32A 500V
56P440	56P450	56P510	56P520	56P532
4P 40A 500V	4P 50A 500V	5P 10A 500V	5P 20A 500V	5P 32A 500V
56P540	56P550			
5P 40A 500V	5P 50A 500V			

参数 Parameter	10		20			32			40		50	
	极数(P) Pole(P)		4	5	3	4	5	3	4	5	4	5
尺寸 Dimension(mm)	a	180	180	180	180	180	180	180	180	180	180	180
	b	78	78	78	78	78	78	78	78	78	78	78

插头 Plug

产品外观
Photo

外形尺寸
Dimension

A

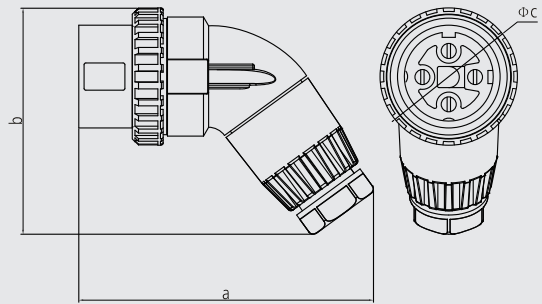

56PA320	56PA332	56PA410	56PA420	56PA432
3P 20A 250V	3P 32A 250V	4P 10A 500V	4P 20A 500V	4P 32A 500V
56PA440	56PA450	56PA510	56PA520	56PA532
4P 40A 500V	4P 50A 500V	5P 10A 500V	5P 20A 500V	5P 32A 500V
56PA540	56PA550			
5P 40A 500V	5P 50A 500V			

参数 Parameter	10		20			32			40		50	
	极数(P) Pole(P)		4	5	3	4	5	3	4	5	4	5
尺寸 Dimension(mm)	a	168	168	168	168	168	168	168	168	168	168	168
	b	130	130	130	130	130	130	130	130	130	130	130
	c	78	78	78	78	78	78	78	78	78	78	78

符合澳大利亚国家标准AS/NZS3112:2005
In line with Australian National Standard AS/NZS 3112:2005

连接器 Connector

产品外观
Photo



外形尺寸
Dimension

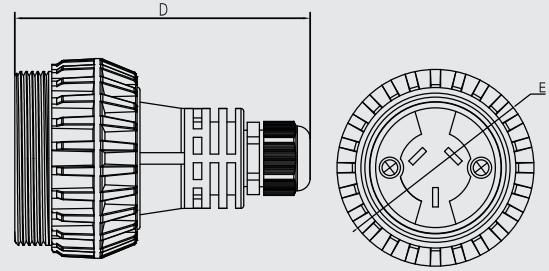

A

56CSC310

56CSC315



3P 10A 250V



3P 15A 250V

参数
Parameter

电流(A) Current(A)	10	15
极数(P) Pole(P)	3	3
尺寸 Dimension(mm)	a	107
	b	70

连接器 Connector

产品外观
Photo

外形尺寸
Dimension

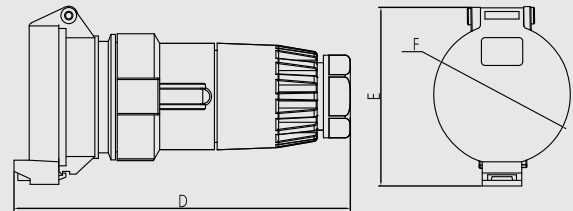

56CSC320



3P 20A 250V

56CSC332



3P 32A 250V

56CSC410



4P 10A 500V

56CSC420



4P 20A 500V

56CSC432



4P 32A 500V

56CSC440



4P 40A 500V

56CSC450



4P 50A 500V

56CSC510



5P 10A 500V

56CSC520



5P 20A 500V

56CSC532



5P 32A 500V

56CSC540



5P 40A 500V

56CSC550



5P 50A 500V

参数
Parameter

电流(A) Current(A)	10		20			32			40		50	
极数(P) Pole(P)	4	5	3	4	5	3	4	5	4	5	4	5
尺寸 Dimension(mm)	a	188	188	188	188	188	188	188	188	188	188	188
	b	97	97	97	97	97	97	97	97	97	97	97
	c	76	76	76	76	76	76	76	76	76	76	76

装置插头 Appliance Inlet

产品外观
Photo



外形尺寸
Dimension

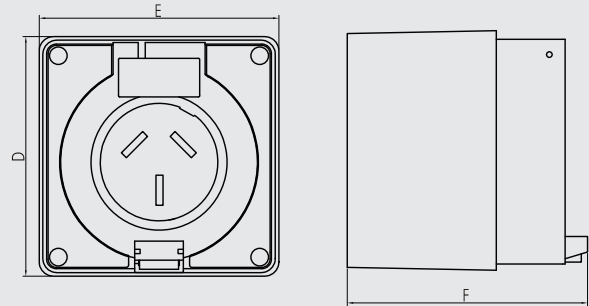

56AI310

56AI315



3P 10A 250V IP66



3P 15A 250V IP66

参数
Parameter

电流(A) Current(A)	10	15
极数(P) Pole(P)	3	3
尺寸 Dimension(mm)	a	101
	b	101
	c	76

装置插头 Appliance Inlet

产品外观
Photo

A



外形尺寸
Dimension

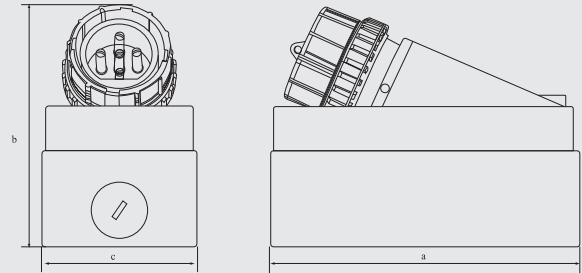

56AI320	56AI332	56AI410	56AI420	56AI432
3P 20A 250V	3P 32A 250V	4P 10A 500V	4P 20A 500V	4P 32A 500V
56AI440	56AI450	56AI510	56AI520	56AI532
4P 40A 500V	4P 50A 500V	5P 10A 500V	5P 20A 500V	5P 32A 500V
56AI540	56AI550			
5P 40A 500V	5P 50A 500V			

参数 Parameter	10		20			32			40		50	
	极数(P) Pole(P)		4	5	3	4	5	3	4	5	4	5
尺寸 Dimension(mm)	a	197	197	197	197	197	197	197	197	197	197	197
	b	138	138	163	163	163	163	163	163	163	163	163
	c	101	101	101	101	101	101	101	101	101	101	101

符合澳大利亚国家标准AS/NZS 3123:2005
In line with Australian National Standard AS/NZS 3123:2005

开关 Switch

产品外观
Photo



外形尺寸
Dimension

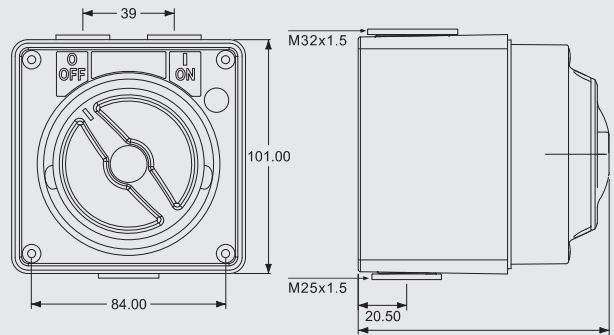

A

	电流(A) Current(A)	极数 Pole	额定工作电压(V) Rated operating voltage (V)	订货号 Model
选型 Description	◆◆ IP 66 开关 ◆◆ IP 66 Switch			
	10	1	250	56SW110-2W
	10	2	250	56SW210
	10	3	500	56SW310
	16	1	250	56SW116
	16	2	250	56SW216
	16	3	500	56SW316
	20	1	250	56SW120
	20	2	250	56SW220
	20	3	500	56SW320
	32	2	250	56SW232
	32	3	500	56SW332
	50	3	500	56SW350

开关 Switch

产品外观
Photo



外形尺寸
Dimension

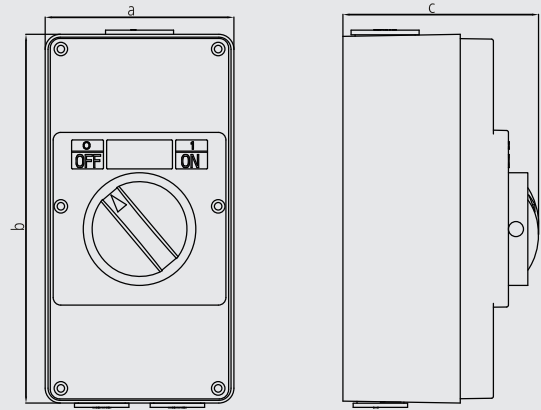

A

电流(A) Current(A)	极数 Pole	额定工作电压(V) Rated operating voltage (V)	订货号 Model
---------------------	------------	---	--------------

选型 Description	◆◆ IP 66 开关 ◆◆ IP 66 Switch			
	电流(A)	极数	额定工作电压(V)	订货号
	10	1	250	56SW110-2W/2
	10	2	250	56SW210/2
	10	3	500	56SW310/2
	16	1	250	56SW116/2
	16	2	250	56SW216/2
	16	3	500	56SW316/2
	20	1	250	56SW120/2
	20	2	250	56SW220/2
	20	3	500	56SW320/2
	32	2	250	56SW232/2
	32	3	500	56SW332/2
	50	3	500	56SW350/2

参数 Parameter	电流(A) Current(A)											
	10			16			20			32		50
	极数(P) Pole(P)			极数(P) Pole(P)			极数(P) Pole(P)			极数(P) Pole(P)		极数(P) Pole(P)
尺寸 Dimension(mm)	a	101	101	101	101	101	101	101	101	101	101	
	b	197	197	197	197	197	197	197	197	197	197	
	c	82	82	82	82	82	82	107	107	107	107	

插座 Socket

产品外观
Photo



外形尺寸
Dimension

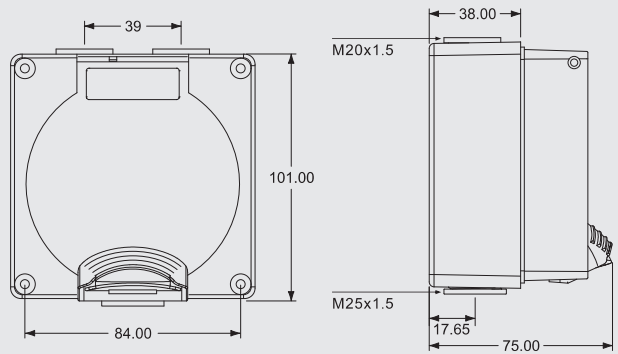

A

56SO310	56SO310W	56SO310F	56SO316F	56SO313*	56SO316**	56SO315
3P 10A 250V	2P/3P 10A 250V	2P/3P 10A 250V	2P/3P 16A 250V	3P 13A 250V	3P 16A 250V	3P 15A 250V
56SO320	56SO332	56SO410	56SO420	56SO432	56SO440	
3P 20A 250V	3P 32A 250V	4P 10A 500V	4P 20A 500V	4P 32A 500V	4P 40A 500V	
56SO450	56SO510	56SO520	56SO532	56SO540	56SO550	
4P 50A 500V	5P 10A 500V	5P 20A 500V	5P 32A 500V	5P 40A 500V	5P 50A 500V	

参数 Parameter	电流(A) Current(A)		10			13		15			20			32			40			50		
	极数(P) Pole(P)		3	4	5	3	3	3	4	5	3	4	5	3	4	5	3	4	5	3	4	5
尺寸 Dimension(mm)	a		101	101	101	101	101	101	101	101	101	101	101	101	101	101	101	101	101	101	101	101
	b		101	101	101	101	101	101	101	101	101	101	101	101	101	101	101	101	101	101	101	101
	c		76	76	76	76	76	76	76	76	76	76	76	76	76	76	76	76	76	76	76	76

符合澳大利亚国家标准AS/NZS3112:2004 AS/NZS3112:2005
In line with Australian National StandardAS/NZS3112:2004 AS/NZS 3112:2005

*符合英国标准 BS1363
*British Standard BS1363

组合开关插座 Combination Switch Socket

产品外观
Photo

A



外形尺寸
Dimension

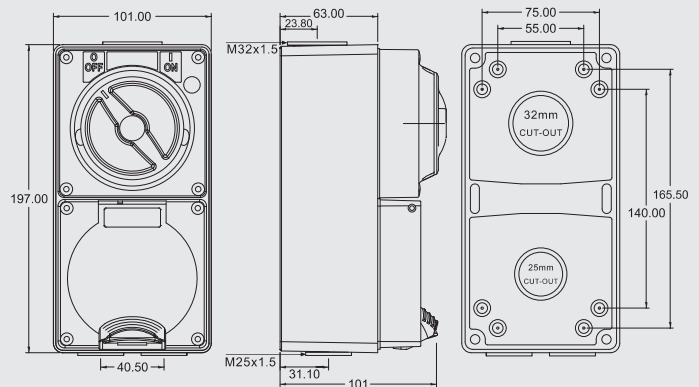

56CV310	56CV310W	56CV310F	56CV316F	56CV313*	56CV316**	56CV315
3P 10A 250V	2P/3P 10A 250V	2P/3P 10A 250V	2P/3P 16A 250V	3P 13A 250V	3P 16A 250V	3P 15A 250V
56CV320	56CV332	56CV410	56CV420	56CV432	56CV440	
3P 20A 250V	3P 32A 250V	4P 10A 500V	4P 20A 500V	4P 32A 500V	4P 40A 500V	
56CV450	56CV510	56CV520	56CV532	56CV540	56CV550	
4P 50A 500V	5P 10A 500V	5P 20A 500V	5P 32A 500V	5P 40A 500V	5P 50A 500V	

参数 Parameter	电流(A) Current(A)														
	10			13	15	20			32			40		50	
极数(P) Pole(P)	3	4	5	3	3	3	4	5	3	4	5	4	5	4	5
尺寸 Dimension(mm)	a	76	76	76	76	76	76	76	76	76	76	76	76	76	76
b	101	101	101	101	101	101	101	101	101	101	101	101	101	101	101
c	197	197	197	197	197	197	197	197	197	197	197	197	197	197	197

符合澳大利亚国家标准AS/NZS3112:2004 AS/NZS3112:2005
In line with Australian National StandardAS/NZS3112:2004 AS/NZS 3112:2005

*符合英国标准 BS1363
*British Standard BS1363

**符合南非标准
**Standard South Africa

金属插头 Metal Plug

产品外观
Photo



外形尺寸
Dimension

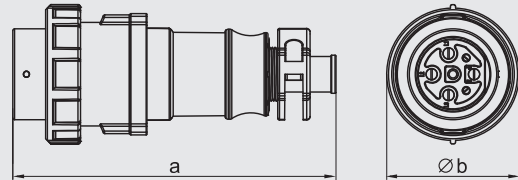

A

MP320 3P 20A 250V	MP332 3P 32A 250V	MP410 4P 10A 500V	MP420 4P 20A 500V	MP432 4P 32A 500V
MP440 4P 40A 500V	MP450 4P 50A 500V	MP510 5P 10A 500V	MP520 5P 20A 500V	MP532 5P 32A 500V
MP540 5P 40A 500V	MP550 5P 50A 500V			

参数 Parameter	尺寸 Dimension	(mm)
	a	190.5
	b	φ 78

金属开关 Metal Switch

产品外观
Photo

外形尺寸
Dimension

A

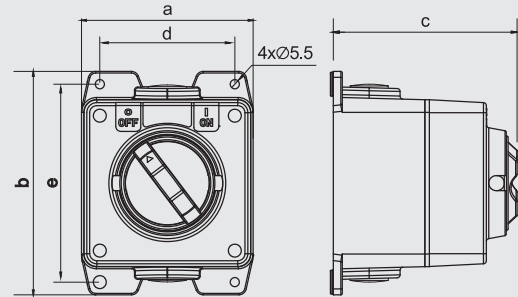

	电流(A) Current(A)	极数 Pole	额定工作电压(V) Rated operating voltage (V)	订货号 Model
选型 Description	◆◆ IP 66 开关 ◆◆ IP 66 Switch			
	10	1	250	MSW110-2W
	10	2	250	MSW210
	10	3	500	MSW310
	16	1	250	MSW116
	16	2	250	MSW216
	16	3	500	MSW316
	20	1	250	MSW120
	20	2	250	MSW220
	20	3	500	MSW320
	32	2	250	MSW232
	32	3	500	MSW332
	50	3	500	MSW350

参数 Parameter	尺寸 Dimension	(mm)
	a	114.5
	b	149
	c	122.5
	d	90
	e	132

金属插座 Metal Socket

产品外观
Photo



外形尺寸
Dimension

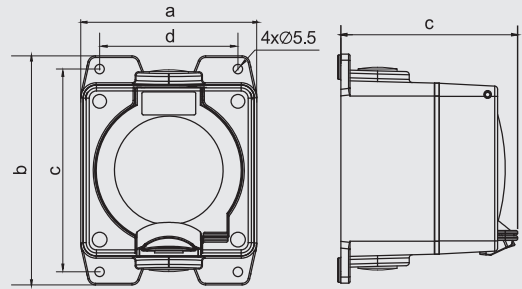

MSO310	MSO315	MSO320	MSO332	MSO410
3P 10A 250V	3P 15A 250V	3P 20A 250V	3P 32A 250V	4P 10A 500V
MSO420	MSO432	MSO440	MSO450	MSO510
4P 20A 500V	4P 32A 500V	4P 40A 500V	4P 50A 500V	5P 10A 500V
MSO520	MSO532	MSO540	MSO550	
5P 20A 500V	5P 32A 500V	5P 40A 500V	5P 50A 500V	

参数
Parameter

尺寸 Dimension	(mm)
a	114.5
b	149
c	115
d	90
e	132

金属开关插座 Metal Combination Switch Socket

产品外观
Photo

A



外形尺寸
Dimension

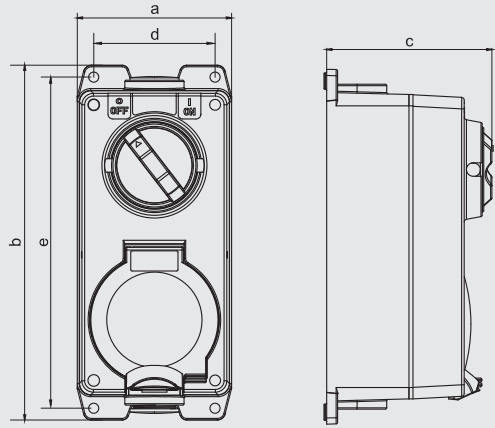

MCV310	MCV315	MCV320	MCV332	MCV410
3P 10A 250V	3P 15A 250V	3P 20A 250V	3P 32A 250V	4P 10A 500V
MCV420	MCV432	MCV440	MCV450	MCV510
4P 20A 500V	4P 32A 500V	4P 40A 500V	4P 50A 500V	5P 10A 500V
MCV520	MCV532	MCV540	MCV550	
5P 20A 500V	5P 32A 500V	5P 40A 500V	5P 50A 500V	

参数
Parameter

尺寸 Dimension	(mm)
a	114.5
b	262.5
c	122.5
d	90
e	245.7

插座带开关、熔断器保护 Switched Socket with Circuit Protection

产品外观
Photo



外形尺寸
Dimension

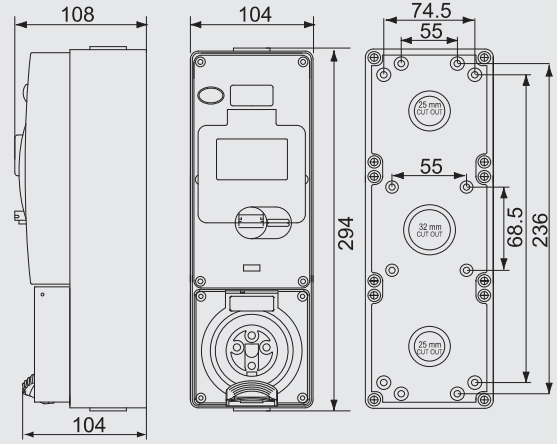

A

56CV-E3001	56CV-E3002	56CV-E3003	56CV-E3004
●● IP 66	●● IP 66	●● IP 66	●● IP 66
1个56CB1-4N	1个56CB1-4N	1个56CB1-4N	1个56CB1-4N
1个插座Soc.10A,3P,230V	1个插座Soc.20A,3P,230V	1个插座Soc.32A,3P,230V	1个插座Soc.20A,5P,400V
1个小型断路器MCB 10A,1P,C	1个小型断路器MCB 20A,1P,C	1个小型断路器MCB 32A,1P,C	1个小型断路器MCB 20A,3P,C

Soc.=Socket
其它不同组合请来电咨询。 Other requirements, please contact us freely

插座带开关、熔断器保护 Switched Socket with Circuit Protection

产品外观
Photo

A



外形尺寸
Dimension

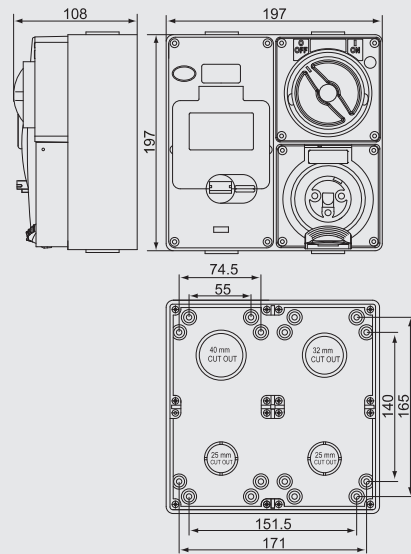

56CV-E4001

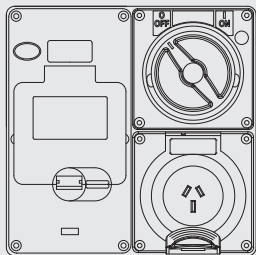

56CV-E4002

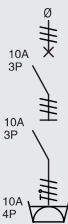
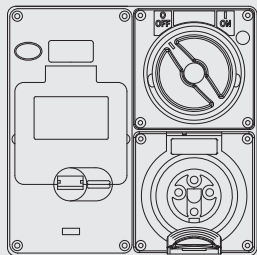

56CV-E4003

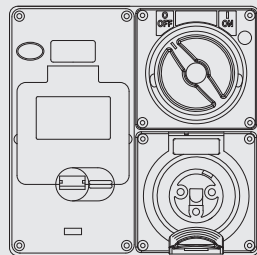

56CV-E4004

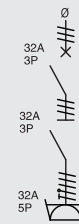
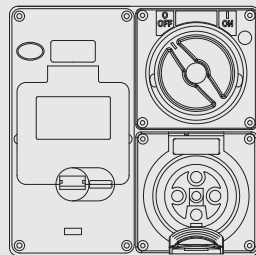

◆◆ IP 66

- 1个56CB1-4N
- 1个隔离开关Isolator Switch
- 1个插座Soc.15A,3P,230V
- 1个小型断路器MCB 15A,1P,C

◆◆ IP 66

- 1个56CB1-4N
- 1个隔离开关Isolator Switch
- 1个插座Soc.10A,4P,400V
- 1个小型断路器MCB 10A,3P,C

◆◆ IP 66

- 1个56CB1-4N
- 1个隔离开关Isolator Switch
- 1个插座Soc.32A,3P,230V
- 1个小型断路器MCB 32A,1P,C

◆◆ IP 66

- 1个56CB1-4N
- 1个隔离开关Isolator Switch
- 1个插座Soc.32A,5P,400V
- 1个小型断路器MCB 32A,3P,C

Soc.=Socket

其它不同组合请来电咨询。 Other requirements, please contact us freely

插座带开关、熔断器保护 Switched Socket with Circuit Protection

产品外观
Photo



外形尺寸
Dimension

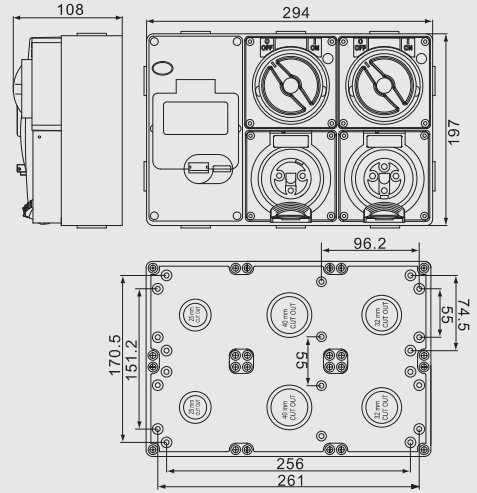

A

56CV-E6001

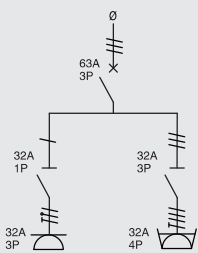
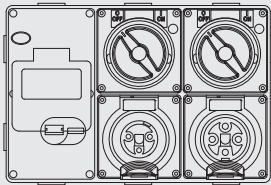

56CV-E6002

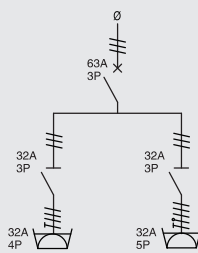
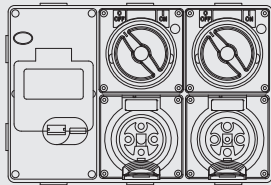

56CV-E6003

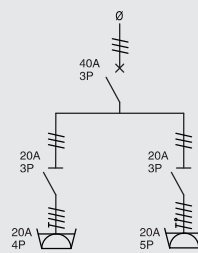
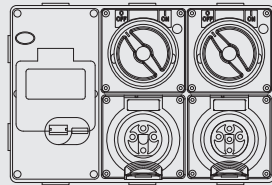

56CV-E6004

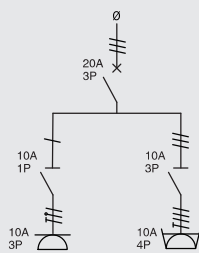
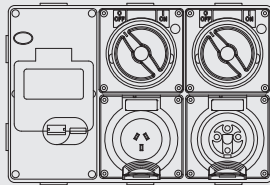

◆◆ IP 66

- 1个56CB1-4N
- 2个隔离开关Isolator Switch
- 1个插座Soc.32A,3P,230V
- 1个插座Soc.32A,4P,400V
- 1个小型断路器MCB 63A,3P,C

◆◆ IP 66

- 1个56CB1-4N
- 2个隔离开关Isolator Switch
- 1个插座Soc.32A,4P,400V
- 1个插座Soc.32A,5P,400V
- 1个小型断路器MCB 63A,3P,C

◆◆ IP 66

- 1个56CB1-4N
- 2个隔离开关Isolator Switch
- 1个插座Soc.20A,4P,400V
- 1个插座Soc.20A,5P,400V
- 1个小型断路器MCB 40A,3P,C

◆◆ IP 66

- 1个56CB1-4N
- 2个隔离开关Isolator Switch
- 1个插座Soc.10A,3P,230V
- 1个插座Soc.10A,4P,400V
- 1个小型断路器MCB 20A,3P,C

Soc.=Socket

其它不同组合请来电咨询。 Other requirements, please contact us freely

插座带开关、熔断器保护 Switched Socket with Circuit Protection

产品外观
Photo

A



外形尺寸
Dimension

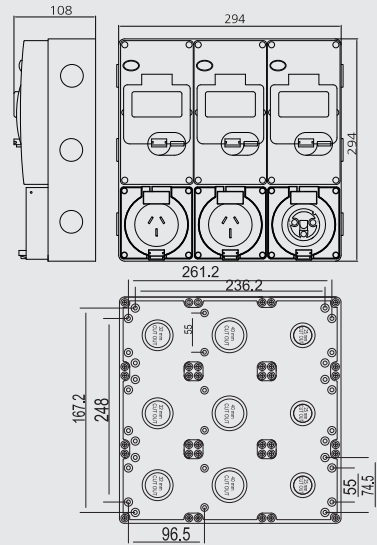

56CV-E9001

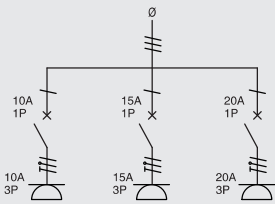
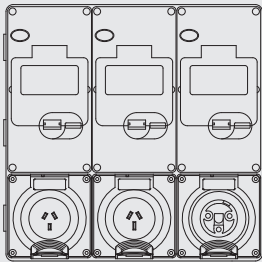

56CV-E9002

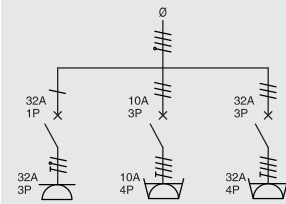
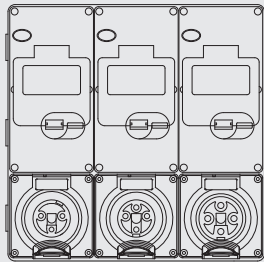

56CV-E9003

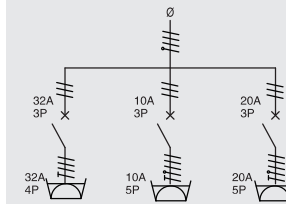
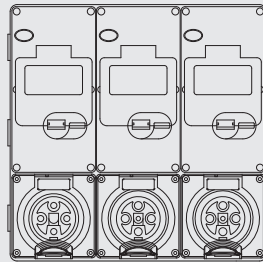

56CV-E9004

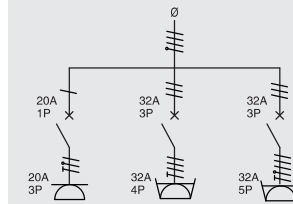
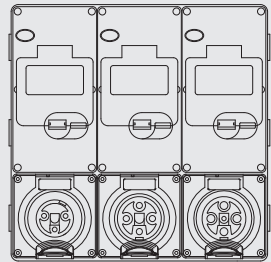

◆◆ IP 66

- 3个56CB1-4N
- 1个插座Soc.10A,3P,230V
- 1个插座Soc.15A,3P,230V
- 1个插座Soc.20A,3P,230V
- 1个小型断路器MCB 10A,1P,C
- 1个小型断路器MCB 15A,1P,C
- 1个小型断路器MCB 20A,1P,C

◆◆ IP 66

- 3个56CB1-4N
- 1个插座Soc.32A,3P,230V
- 1个插座Soc.10A,4P,400V
- 1个插座Soc.32A,4P,400V
- 1个小型断路器MCB 32A,1P,C
- 1个小型断路器MCB 10A,3P,C
- 1个小型断路器MCB 32A,3P,C

◆◆ IP 66

- 3个56CB1-4N
- 1个插座Soc.32A,4P,400V
- 1个插座Soc.10A,5P,400V
- 1个插座Soc.20A,5P,400V
- 1个小型断路器MCB 32A,3P,C
- 1个小型断路器MCB 10A,3P,C
- 1个小型断路器MCB 20A,3P,C

◆◆ IP 66

- 3个56CB1-4N
- 1个插座Soc.20A,3P,230V
- 1个插座Soc.32A,4P,400V
- 1个插座Soc.32A,5P,400V
- 1个小型断路器MCB 20A,1P,C
- 2个小型断路器MCB 32A,3P,C

Soc.=Socket

其它不同组合请来电咨询。 Other requirements, please contact us freely

插座带开关、熔断器保护 Switched Socket with Circuit Protection

产品外观
Photo



外形尺寸
Dimension

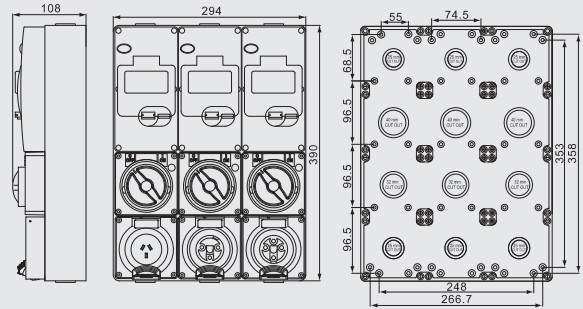

A

56CV-E12001

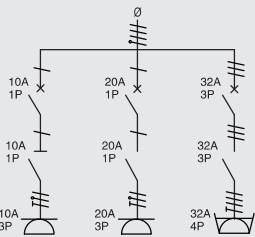
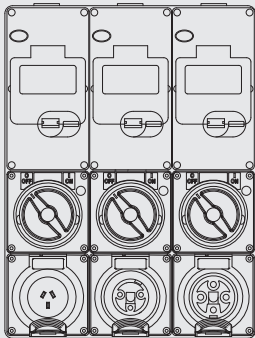

56CV-E12002

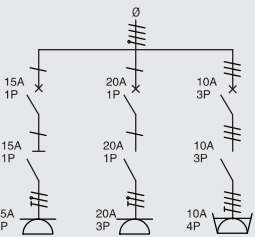
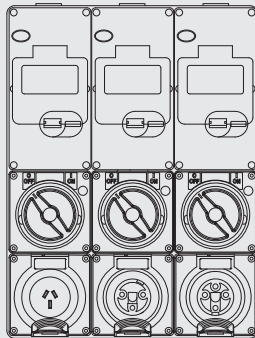

56CV-E12003

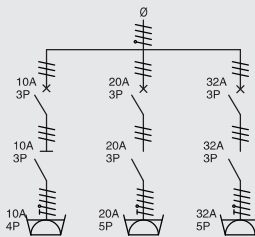
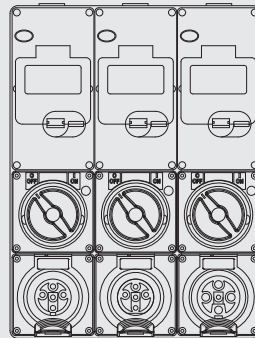

56CV-E12004

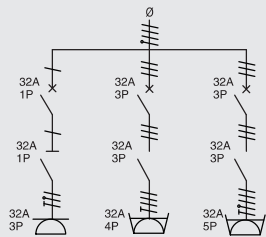
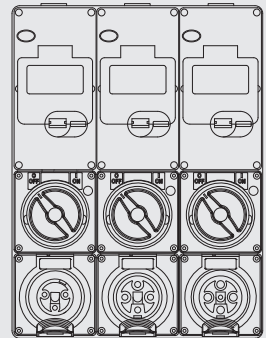

◆◆ IP 66

- 3个56CB1-4N
- 3个隔离开关Isolator Switch
- 1个插座Soc.10A,3P,230V
- 1个插座Soc.20A,3P,230V
- 1个插座Soc.320A,4P,400V
- 1个小型断路器MCB 10A,1P,C
- 1个小型断路器MCB 20A,1P,C
- 1个小型断路器MCB 320A,3P,C

◆◆ IP 66

- 3个56CB1-4N
- 3个隔离开关Isolator Switch
- 1个插座Soc.10A,3P,230V
- 1个插座Soc.20A,3P,230V
- 1个插座Soc.20A,4P,400V
- 1个小型断路器MCB 10A,1P,C
- 1个小型断路器MCB 20A,1P,C
- 1个小型断路器MCB 20A,3P,C

◆◆ IP 66

- 3个56CB1-4N
- 3个隔离开关Isolator Switch
- 1个插座Soc.10A,5P,230V
- 1个插座Soc.20A,5P,400V
- 1个插座Soc.32A,5P,400V
- 1个小型断路器MCB 10A,3P,C
- 1个小型断路器MCB 20A,3P,C
- 1个小型断路器MCB 32A,3P,C

◆◆ IP 66

- 3个56CB1-4N
- 3个隔离开关Isolator Switch
- 1个插座Soc.32A,3P,230V
- 1个插座Soc.32A,4P,400V
- 1个插座Soc.32A,5P,400V
- 1个小型断路器MCB 32A,1P,C
- 2个小型断路器MCB 32A,3P,C

Soc.=Socket

其它不同组合请来电咨询。 Other requirements, please contact us freely

插座 Socket

产品外观
Photo

A



外形尺寸
Dimension

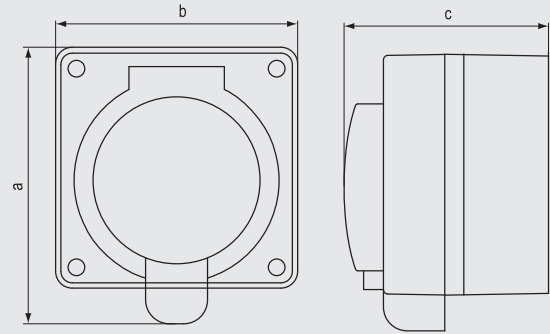

电流(A) Current(A)	极数 Pole	额定工作电压(V) Rated operating voltage (V)	订货号 Model
---------------------	------------	---	--------------

▲ IP 55 插座
▲ IP 55 Socket

15	2P+⊕	250V	56UKO-DG	
13	2P+⊕	250V	56UKO-313	
10	2P+⊕/2P	250V	56UKO-310W	

选型
Description

参数
Parameter

电流(A) Current(A)	15	13
极数(P) Pole(P)	2P+⊕	2P+⊕
尺寸 Dimension(mm)	a	116
	b	101.5
	c	86

开关插座 Switched Socket

产品外观
Photo



外形尺寸
Dimension

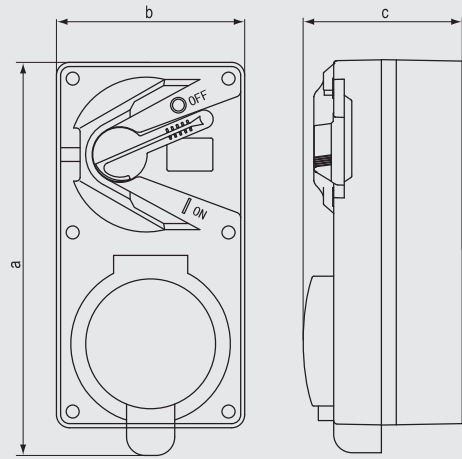

A

电流(A) Current(A)	极数 Pole	额定工作电压(V) Rated operating voltage (V)	订货号 Model
---------------------	------------	---	--------------

▲ IP 55 开关带插座
▲ IP 55 Switched Socket

选型
Description

15	2P+⊕	250V	56UKC-DG	
13	2P+⊕	250V	56UKC-313	
10	2P+⊕/2P	250V	56UKC-310W	

参数
Parameter

电流(A) Current(A)	15	13
极数(P) Pole(P)	2P+⊕	2P+⊕
尺寸 Dimension(mm)	a	212
	b	101.5
	c	86

开关与插座 Switch Socket

A



插座 Socket
15A-250V~ 表面安装
IP55 Surface mount

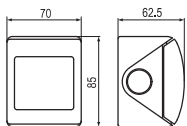

1联开关 1 Gang switch
13A-250V~ 表面安装
IP55 Surface mount

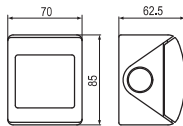

开关插座 Switch socket
15A-250V~ 表面安装
IP55 Surface mount

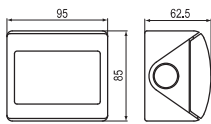

2联开关 2 Gang switch
13A-250V~ 表面安装
IP55 Surface mount

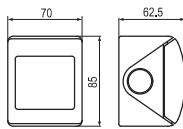

开关插座 Switch socket
15A-250V~ 表面安装
IP55 Surface mount

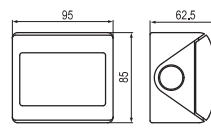

3联开关 3 Gang switch
13A-250V~ 表面安装
IP55 Surface mount

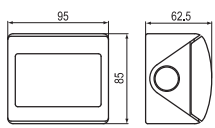

开关插座 Switch socket
15A-250V~ 表面安装
IP55 Surface mount

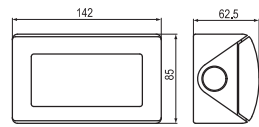

4联开关 4 Gang switch
13A-250V~ 表面安装
IP55 Surface mount

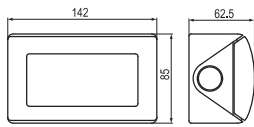
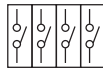

插座 Socket
15A-250V~ 表面安装
IP55 Surface mount

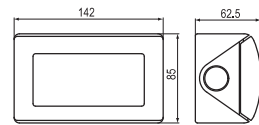

单联门铃开关 Single-joint bell switch
16A-250V~ 表面安装
IP55 Surface mount

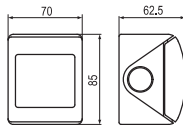

开关与插座 Switch Socket

A



1联双控开关 1 Gang 2 Way switch
13A-250V~ 表面安装
IP55 Surface mount

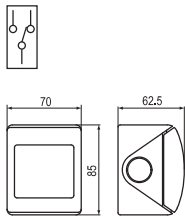

1联两极开关 1 Gang switch double pole
13A-250V~ 表面安装
IP55 Surface mount

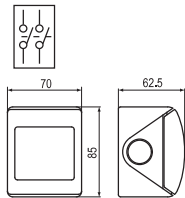

2联双控开关 2 Gang 2 Way switch
13A-250V~ 表面安装
IP55 Surface mount

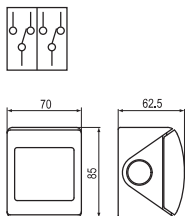

2联两极开关 2 Gang switch double pole
13A-250V~ 表面安装
IP55 Surface mount

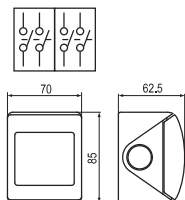

3联双控开关 3 Gang 2 Way switch
13A-250V~ 表面安装
IP55 Surface mount

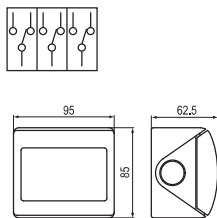

3联两极开关 3 Gang switch double pole
13A-250V~ 表面安装
IP55 Surface mount

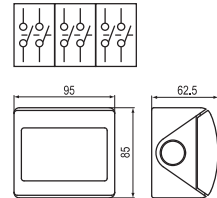

4联双控开关 4 Gang 2 Way switch
13A-250V~ 表面安装
IP55 Surface mount

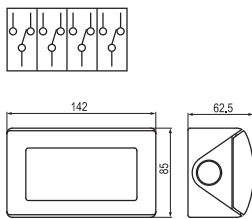

4联两极开关 4 Gang switch double pole
13A-250V~ 表面安装
IP55 Surface mount

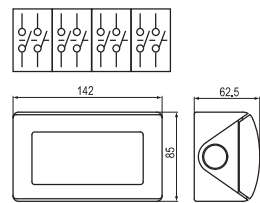

插座 Socket
15A-250V~ 表面安装
IP55 Surface mount

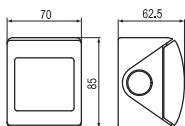

开关插座 Switched Socket
15A-250V~ 表面安装
IP55 Surface mount

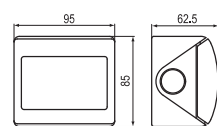

开关与插座 Switch Socket

A



插座 Socket
13A-250V~ 表面安装
IP55 Surface mount

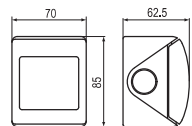

插座 Socket
16A-250V~ 表面安装
IP55 Surface mount

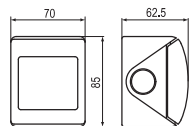

开关插座 Switch socket
13A-250V~ 表面安装
IP55 Surface mount

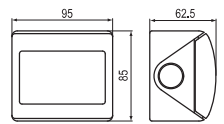

开关插座 Switch socket
16A-250V~ 表面安装
IP55 Surface mount

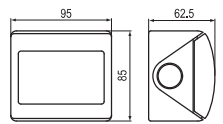

开关插座 Switch socket
13A-250V~ 表面安装
IP55 Surface mount

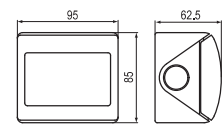

开关插座 Switch socket
16A-250V~ 表面安装
IP55 Surface mount

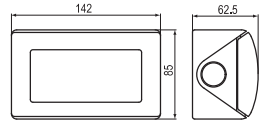

开关插座 Switch socket
13A-250V~ 表面安装
IP55 Surface mount

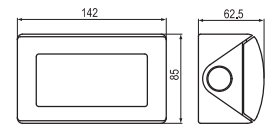

插座 Socket
16A-250V~ 表面安装
IP55 Surface mount

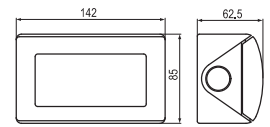

插座 Socket
13A-250V~ 表面安装
IP55 Surface mount

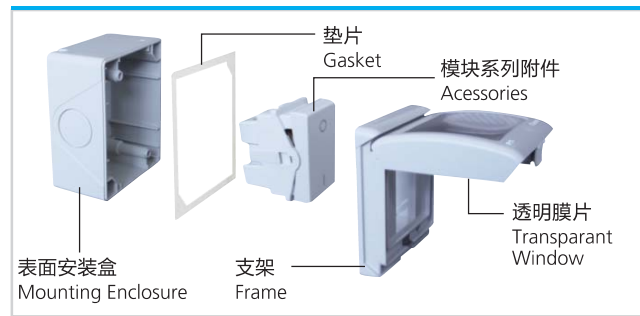
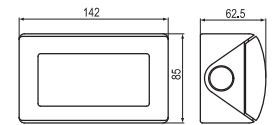

开关与插座 Switch Socket

A



插座 Socket
15A-250V~ 表面安装
IP55 Surface mount

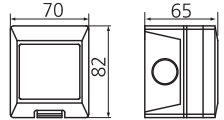

1联开关 1 Gang switch
13A-250V~ 表面安装
IP55 Surface mount

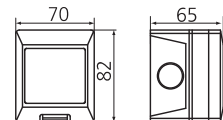

开关插座 Switch socket
15A-250V~ 表面安装
IP55 Surface mount

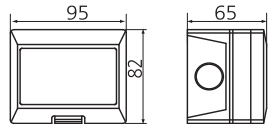

2联开关 2 Gang switch
13A-250V~ 表面安装
IP55 Surface mount

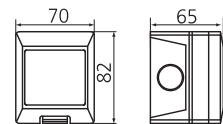

开关插座 Switch socket
15A-250V~ 表面安装
IP55 Surface mount

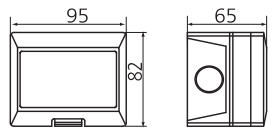

3联开关 3 Gang switch
13A-250V~ 表面安装
IP55 Surface mount

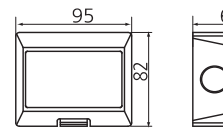

插座 Socket
13A-250V~ 表面安装
IP55 Surface mount

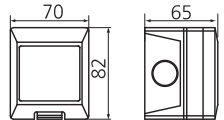

开关插座 Switch socket
13A-250V~ 表面安装
IP55 Surface mount

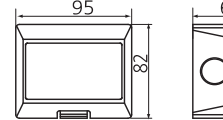

开关插座 Switch socket
13A-250V~ 表面安装
IP55 Surface mount

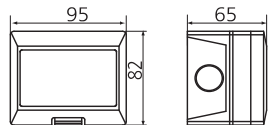

单联门铃开关 Single-joint bell switch
16A-250V~ 表面安装
IP55 Surface mount

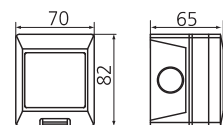

开关与插座 Switch Socket

A



1联双控开关 1 Gang 2 Way switch
13A-250V~ 表面安装
IP55 Surface mount

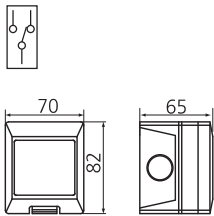

1联两极开关 1 Gang switch double pole
13A-250V~ 表面安装
IP55 Surface mount

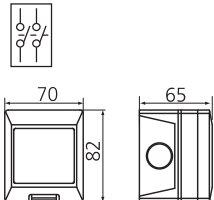

2联双控开关 2 Gang 2 Way switch
13A-250V~ 表面安装
IP55 Surface mount

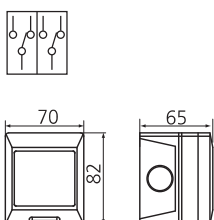

2联两极开关 2 Gang switch double pole
13A-250V~ 表面安装
IP55 Surface mount

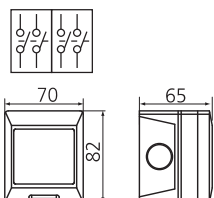

3联双控开关 3 Gang 2 Way switch
13A-250V~ 表面安装
IP55 Surface mount

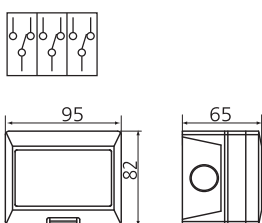

3联两极开关 3 Gang switch double pole
13A-250V~ 表面安装
IP55 Surface mount

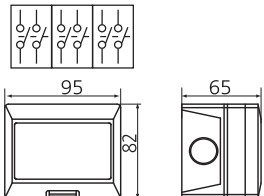

插座 Socket
16A-250V~ 表面安装
IP55 Surface mount

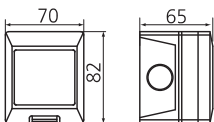

开关插座 Switch socket
16A-250V~ 表面安装
IP55 Surface mount

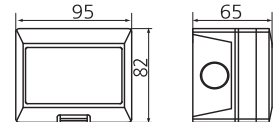



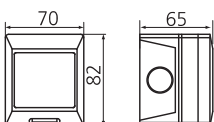



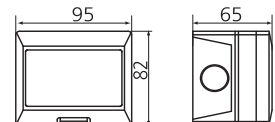

插座 Socket
15A-250V~ 表面安装
IP55 Surface mount

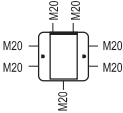
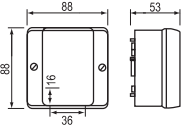

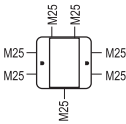
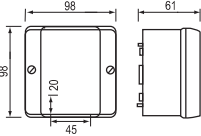
开关插座 Switched socket
15A-250V~ 表面安装
IP55 Surface mount

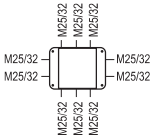
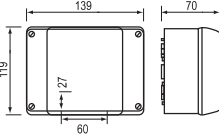

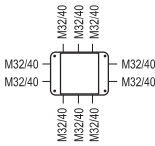
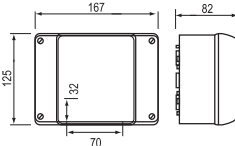
接线盒(IP55/IP66) Junction Box (IP55/IP66)

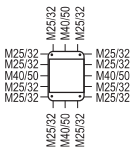
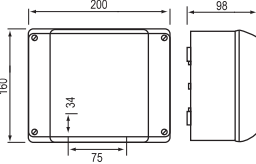
型号 Model	管式连接(插入式) Pipe connection (plug-in)	导线接入孔(公制) Wire access hole (Metric)	尺寸 Dimension
	D 9020Z 4 ESM20适用导线 Applicable wire 6-13mm		
	D 9025Z 带端子 With terminal 2.5mm ² ,20A,AC400V 3~ 4mm ² ,25A, AC250V 1~		
	D 9040Z 4 ESM25适用导线 Applicable wire ϕ 9-17mm		
	D 9045Z 带端子 With terminal 4mm ² ,25A,AC400V 3~ 6mm ² ,32A, AC250V 1~		
	K 9060Z 3 ESM32适用导线 Applicable wire ϕ 9-23mm		
	K 9065Z 带端子 With terminal 6mm ² ,32A,AC400V 3~ 10mm ² ,50A,AC250V 1~		
	K 9100Z 3 ESM32适用导线 Applicable wire ϕ 9-23mm		
	K 9105Z 带端子 With terminal 10mm ² ,50A,AC400V 3~ 16mm ² ,65A,AC250V 1~		
	K 9250Z 3 ESM40适用导线 Applicable wire ϕ 17-30mm		
	K 9255Z 带端子 With terminal 25mm ² ,85A,AC400V 3~ 35mm ² ,100A,AC250V 1~		



开关、插座 Switch Socket

56SW320F/R

56SW332C/O

A



20A 500V IP66



32A 500V IP66

56SW363F/R

56SW363C/O



40A 500V IP66



63A 500V IP66

56/32

56CS0313(N)

56CSC313(N)



10A 250V IP56



13A 250V IP56



13A 250V IP56

开关、插座 Switch Socket

WSC226



16A 250V IP56

WSC226/2



16A 250V IP56

A

WSC227



10A/15A 250V IP53

WSC227/2



10A/15A 250V IP53

LXP-416



16A 400V 4P

LXC-416



16A 400V 4P

按钮控制盒 Push Button Control Box

56PB



IP66

56/2PBS1



IP66

A

56PBS



IP66

56/2PB



IP66

56PBS1



IP66

56PBS2



IP66

接线盒 Junction Box

A

56系列接线盒
56 series junction box



56系列接线盒
56 series junction box



56系列上盖
56 series Lid

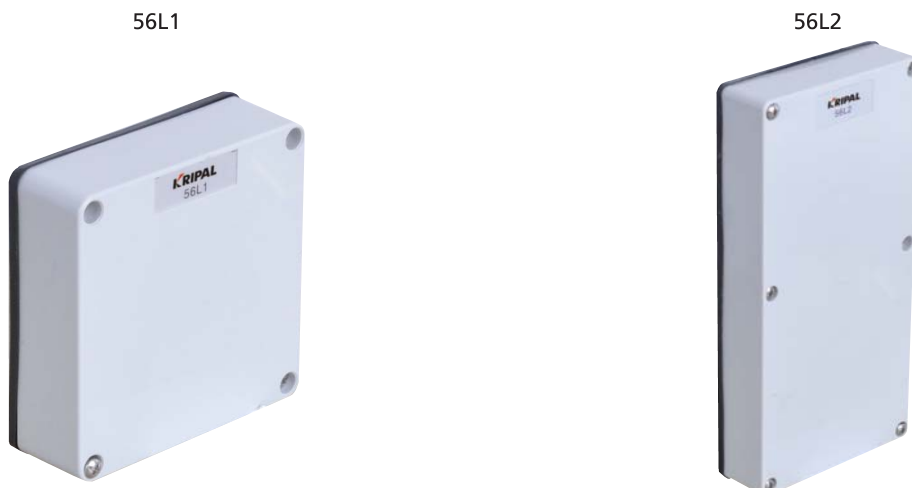

接线盒 Junction Box

56系列 底座
56 Series Back box

A



56系列 底座
56 Series Back box



56系列 底座
56 Series Back box

